

GEM Remotes

356 Capri Blvd. Naples, FL 34113

Page 1 6-25-15
Wires GEM instructions 2015

Phone Number: **Read Troubleshooting Section First!**

Email: info@gemremotes.com WWW.GEMREMOTES.COM

Read All Directions Prior to Installation! Installation should be done By a qualified technician and be wired to the National Electric Code.

Customer user instructions are printed on the yellow face card inside the GEM box make sure they are read before use! Use of other wiring directions could result in damage to your GEM unit and/or the motors.

We have 30 years of experience. We recommend that you read and use the Step by Step Wiring Procedures before starting the installation. It could save you time and money.

Step by Step Wiring Procedures:

To ensure proper installation of your GEM Controller, use our directions in lieu of all others.

Tools: Philip's #2 and a flat head screwdriver, wire strippers, volt meter, wire cutters, wrench and wire nuts.

1. **Turn off power at the circuit breaker. Check with a volt meter** that you have 0 volts. Overload protection is not provided inside the GEM unit. Use properly sized circuit breaker and wire size based on total horsepower of motors. See wire chart below.
2. Remove face card screws, slowly open (be careful of the tail on the back side) if necessary unplug tail by pulling on black plastic part
3. Cut off drum (hand) switches, GEM units are not designed to be used in conjunction with these switches. Strip main feed and motor wires inside the GEM unit. If your drum switch had a corded GFI, you can use one as the main feed wire (120VAC only)
- 3.5 GEM offered a GFI inside the GEM unit from 1990 to 2013 if your unit has a GFI in the GEM unit find those instructions to wire unit
4. Main feed black goes to the Lug on bottom left side of the contactor marked L1. **For 120VAC units you must hook up your Neutral (white) to L2 and also attach the GEM supplied white wire with a yellow tip to L2. (see page 4 1B) We recommend that your GEM unit be wired at 240VAC with a neutral. Wiring at 240VAC the neutral goes to the neutral bar on the bottom right side of the box your other main feed goes to L2. If you have neutral then do not rewire transformer. Also when wired at 240vac do not attach the GEM supplied white wire to L2. Special order 240 or 208VAC do not rewire transformer. If the unit is wired for 240VAC then your motors must be rewired for 240VAC. If you don't have a Neutral then see page 4 line #13.**
5. Connect Motor #1 wires to Lugs on bottom right side of the contactor as labeled: **Motor #1 Red(top), M#1 Black(middle), M#1 Orange(bottom). Motor #1 wires are on the same side of the lift as the limit switch (if auto-stop unit). When wiring at 120 VAC connect motor white wires to GEM motor neutral bar (Motor White wires not used at 240VAC)** Motor #2 wires if a two motor system, attach wires color to color inside the GEM box (coming off the level switch) using wire nuts. If your lift only has one motor and you have a GR2 don't use Motor #2 wires, cap them off.
6. Connect green or bare wires to Green wire on the transformer. Green or bare wires must only be used as a ground. **It is unsafe to use a ground as a neutral.**

Use this chart to size wire and circuit protection. Measure the distance between the main breaker and the motors.

Recommended Wire Size for Installation of your GEM Controller-1 Phase, 75C Copper Wire

# of Motors	Motor HP	120 Volt AC Main Feed							240 Volt AC Main Feed						
		Amps to run	Breaker Size	50 Feet	100 Feet	200 Feet	300 Feet	400 Feet	Amps to run	Breaker Size	50 Feet	100 Feet	200 Feet	300 Feet	400 Feet
1	1/2	8.8	10 Amps	12	10	6	4	4	4.4	5 Amps	14	14	12	10	10
1	3/4	10.8	15	12	8	6	4	3	5.4	10	14	14	12	12	10
1	1	12.8	15	10	8	6	4	3	6.4	10	14	14	12	12	10
1	1 1/2	17.0	20	10	6	4	2	1	8.5	10	14	14	10	10	8
2	1/2	17.6	20	10	6	4	2	1	8.8	10	12	12	10	8	6
2	3/4	21.6	25	8	6	3	1	----	10.8	15	12	12	10	8	6
2	1	25.6	30	8	4	2	1	----	12.8	15	12	10	8	6	4
2	1 1/2	34.0	35	6	4	1	2/0	----	17.0	20	12	10	8	4	2
4	1/2	----	----	----	----	----	----	----	17.6	20	12	10	6	4	4
4	3/4	----	----	----	----	----	----	----	21.3	25	12	8	6	4	3
4	1	----	----	----	----	----	----	----	26.0	30	10	8	4	3	2
4	1 1/2	----	----	----	----	----	----	----	36	35	10	6	4	2	1
4	2	----	----	----	----	----	----	----	44.8	45	8	6	3	1	1/0

Breaker sizes are our recommendation. Please use motor label for proper size and code compliance.

- Open motor covers and configure motor wires as shown below. **You may have to move wires inside the motor even though the hand switches worked(Regal Beloit's AO Smith motors)!** If your motor has terminals inside, check for the motor diagram on the next page otherwise use the **Standard T Numbered Wired motor** drawing or the **Standard color motor-wired drawing** below. **AO Smith 120/240 vac wired with terminals is below on the right, AO Smith 120 vac only motors are on the next page.** Inspect wires inside each motor to ensure proper wire connections. Failure to do so could damage your motors. **Not wired color to color inside the motor!** To reverse motor starting direction, swap wires **inside the motor!** Some motors have circuit protection and output wires from these might have different color wires. Also, some manufacturers pre-wire their motors with wires that don't match GEM wires. Some substitutions are blue for a green(ground), and yellow for a white wire.
- If the GEM part # on the left side of the door has an "A" then your unit is an Auto-Stop. Your unit will not work without the limit switch wires hooked up. **Check that your lift stops in both the up and the down direction!** An Auto-Stop unit must have GEM limit switches installed. **Failure to do so could result in damage to your lift and/or the boat and is against code and not insured.** See the auto-stop LED on the top of the unit. When red, the unit is in the auto-run mode, if it is flashing fast the lift is at the up limit and if slow then it is at the down limit. To toggle in and out of Auto-Stop(run) mode press the auto-stop button.
- Attach the face card electronic tail to the receiver board, pin #1 goes on the left, replace face card screws.
- To level the lift, turn off the Auto-stop mode(if equipped). Hold the level switch in the off position. This will turn off power to motor #2. While holding it down raise or lower one side. **Do not let go of the level switch until the lift has stopped.**
- Turn off the unit when not in use. Make sure the owner reads operating instructions printed on the yellow face card. Test the GFI** (if equipped) once every month and/or before each use. The emergency override holes bypasses GFI protection, and if the GFI is buzzing stop or the GFI will be damaged! GEM units have a three second delay before switching directions. This ensures that the motors go in the right direction.
- A replacement transmitter (#7240) or a spare can be bought online at www.gemremotes.com. Loss of range or unit hiccups check battery, 2: 3 volts (Cr2032). Old, 6230 transmitters will not work with this unit.

Note: drum switch wire Orange might be pre-wired to Motor Blk(T5)*. GEM Orange needs to be attached to Pin2 or Motor Yel/T4. **240VAC WIRING with neutral (not GEM GFI units)**

Standard "T#" or # Wires Wired at 120 VAC. wire inside the motor!!!!

AO Smith, Baldor, Dayton, Deco GE, Electorgear, Emerson, Iron horse, Leeson, Lincon, Marathon, SMC, WEG & other "T#" motors (P1 is input for thermal overload protection)

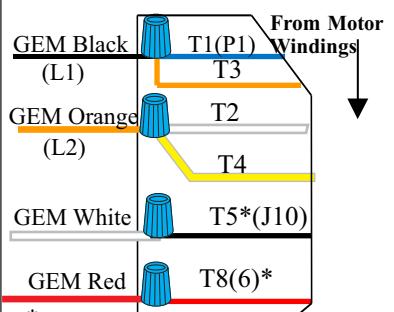

*To change motor direction, switch T5 & T8 motor wires.
To change from 120 to 240VAC:
 1. Cap GEM White wire (not used).
 2. Attach 3 motor wires together T3, T5* and T2.
 3. FYI: GEM Blk to T1(P1), GEM Orange to T4, GEM Red to T8(6)*.

Standard "T#" or # Wires Wired at 240 VAC.

AO Smith, Baldor, Dayton, Deco GE, Electorgear, Emerson, Iron horse, Leeson, Lincon, Marathon, SMC, WEG & other "T#" motors (P1 is input for thermal overload protection)

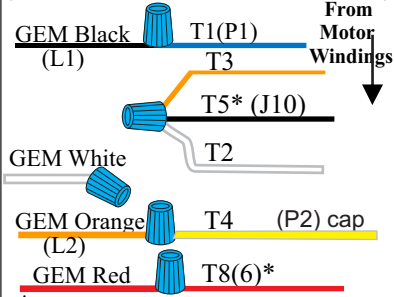

*To change motor direction, switch T5 & T8 motor wires inside the motor!!!!

Standard Colored Motor Wired at 120 VAC. wire inside the motor!!!!

A.O. Smith, Baldor, Dayton, Electorgear, Emerson, Elite, Iron horse, Leeson, Lincon, Marathon and other Colored Motor wires

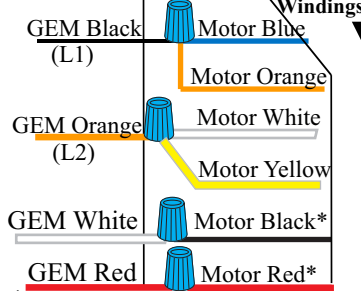

*To change motor direction, switch Motor Red and Motor Black wires.
To change from 120 to 240VAC:
 1. Cap GEM White wire (not used).
 2. Attach 3 motor wires together M Orange, M Blk* and M White.
 3. FYI: GEM Black to Motor Blue, GEM Orange to Motor Yellow, GEM Red to Motor Red*.

Standard Colored Motor Wired at 240 VAC.

A.O. Smith, Baldor, Dayton, Electorgear, Emerson, Iron horse, Leeson, Lincon, Marathon and other Colored Motor wires

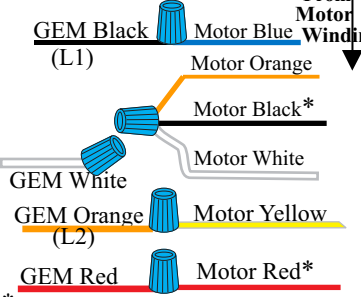

*To change motor direction, switch Motor Red and Motor Black wires inside the motor!

Regal Beloit's A.O. SMITH 120/240VAC Wired at 120 VAC.

Note: drum switch Orange might be pre-wired to Motor Black*. GEM Orange needs to be on pin 2. Also move White wires. See below.

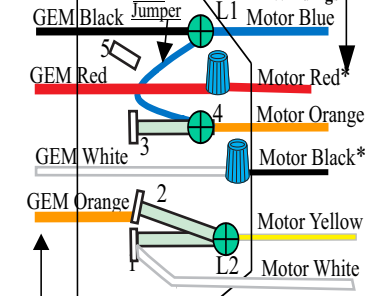

Wiring From GEM Unit
 *To change motor direction, switch Motor Black & Motor Red wires.

- To change from 120 to 240VAC:**
- Cap GEM White wire (not used).
 - Place Motor Black on pin 4.
 - Move Motor Blue jumper from pin 4 to pin 5.
 - GEM Orange is on pin 2!!!!!!**
 - Move Motor White from pin 1 to 3.

Regal Beloit's A.O. SMITH 120/240VAC Wired at 240VAC.

Note: Drum switch Orange might be pre-wired to Motor Black*. GEM Orange needs to be on pin 2. Also move Motor White and Motor Black wires to pin 4 and 3.

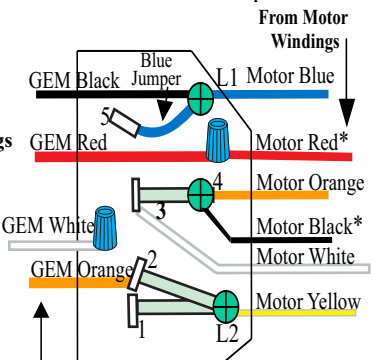

*To change motor direction, switch Motor Black & Motor Red wires.
Wiring From GEM Unit

neutral (not GEM GFI units) Main Feed Connections

Hook your Main feed Neutral wire to motor white neutral bar. If you don't ave a Neutral rewire transformer see page 4 line 13.

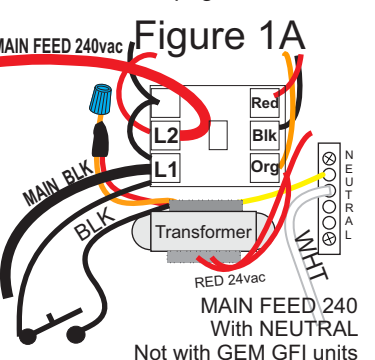

Run Light or Brake

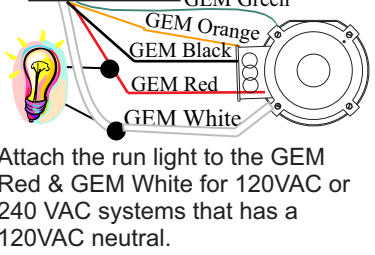

Attach the run light to the GEM Red & GEM White for 120VAC or 240 VAC systems that has a 120VAC neutral.
 To run a 120VAC brake attach wires to GEM Orange and GEM Black when main feed is at 120VAC. If 240VAC brake is used, use GEM Orange and Blk. If you have 240VAC system and you only have a 120VAC brake then you must use GEM White & GEM Red. (The GEM white wire will be used at 240VAC).

BALDOR

(BALDOR "T" NUMBERED WIRES SEE NUMBERED WIRE DRAWING) **Wired at 120VAC** From Motor Windings

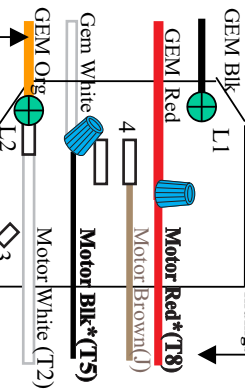

Wiring From GEM Unit *To change motor direction, switch Motor Black(T5) & Motor Red(T8) wires.
To change from 120 to 240VAC:
 1. Cap GEM White wire (not used).
 2. Place M Blk*(T5) on pin 4.
 3. Move M Brn(I) from pin 4 to pin 3.
 4. Move M WHT(T2) from L2 to pin 4.

BALDOR

(BALDOR "T" NUMBERED WIRES SEE NUMBERED WIRE DRAWING) **Wired at 240VAC** From Motor Windings

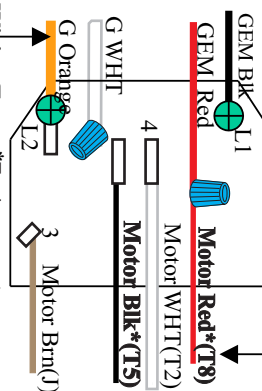

Wiring From GEM Unit *To change motor direction, switch M Blk(T5) & Motor Red(T8) wires.

Elite Wired @120 VAC

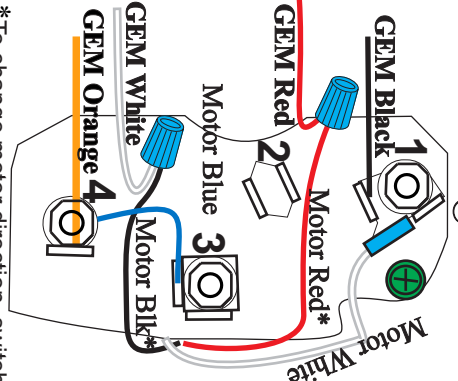

*To change motor direction, switch Motor Black & Motor Red wires.

To change from 120 to 240VAC:

1. Place Motor Black on pin 3!!!!!!
2. Move Motor White from pin 1 to 3
3. Cap GEM White wire (not used)
4. Move Motor Blue jumper from pin 3 to pin 2.

Elite Wired @ 240 VAC

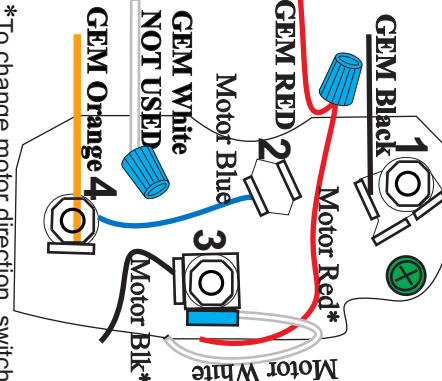

*To change motor direction, switch Motor Black & Motor Red wires.

Century AC/A.O. SMITH

C412, C426 AND C523 **Wired @ 120 VAC** From Motor Windings

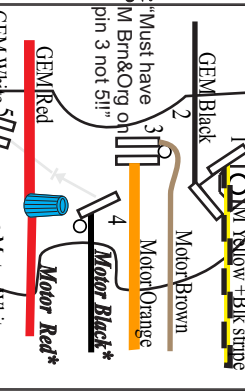

*Must have M Brn&Org on pin 3 not 5!!
Wiring From GEM Unit *To change motor direction at 120 only switch motor Blk and motor Red wires.
To change from 120vac to 240:
 1. Cap GEM White wire (not used).
 2. Move Motor Orange from 3 to 5.
 3. Attach M Wht & M Org on pin 5.
 4. FYI: GEM Org & M Yellow on 6.
 Motor Blk on 4.

Century AC/A.O. SMITH

C412, C426 AND C523 **Wired @240 VAC** From Motor Windings

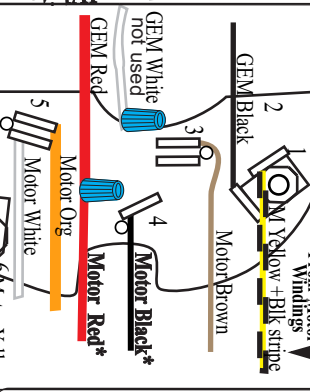

Wiring From GEM Unit *To change motor direction, switch Motor Black & Motor Red wires!

Century AC/A.O. SMITH

C926 **Wired @ 120 VAC** From Motor Windings



*To change motor direction, switch Motor Red & Motor Yellow wires!
To change from 120vac to 240:
 1. Cap GEM White wire (not used).
 2. Move Motor White from WHT & Org to M R.
 3. Move Motor Yellow from 6 to 5.
 4. FYI: GEM Blk to M Blk, GEM R to M R, GEM Orange to M Blue.

Marathon/GE

Wired @ 120 VAC Motor Windings

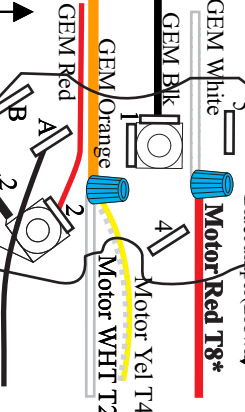

Wiring From GEM Unit *To change direction, switch Motor Black T5, & Motor Red T8 wires.
To change from 120vac to 240:
 1. Cap GEM White wire (not used).
 2. Move Blue Jumper from 5 to 4.
 3. Attach M Wht & M Red*(T8) on pin 5.
 4. FYI: GEM Org & M Yellow together.

LEESON/Ace

Wired at 120 VAC From Motor Windings



Wiring From GEM Unit *To change motor direction switch GEM Org & GEM Blk wires
To change from 120vac to 240:
 1. Move GEM White from pin 5 to 6.
 2. Move motor Purple wire from 1 to 5.
 3. Move motor Brown wire from 2 to 5.
 4. *To change direction of the motor switch GEM Org & GEM Black wires.

LEESON/Ace

Wired at 240 VAC From Motor Windings

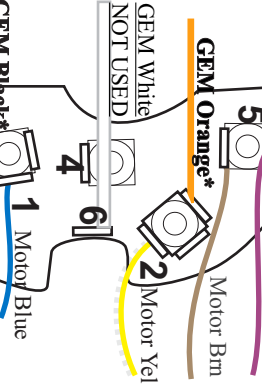

Wiring From GEM Unit *To change motor direction switch GEM Org & GEM Blk wires

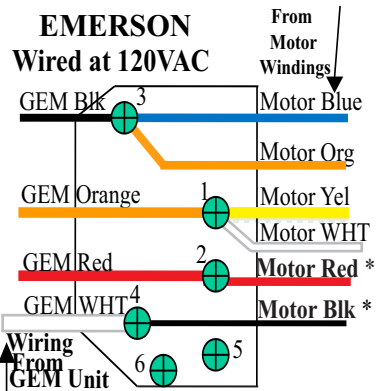

EMERSON **Wired at 120VAC** From Motor Windings
Wiring From GEM Unit *To change motor direction, switch Motor Blk and Motor Red wires.
To change from 120vac to 240:
 1. Cap GEM White wire.
 2. Attach 3 m wires on 4 M WHT, M Blk* & M Org.
 3. FYI: GEM Blk & Motor Blue on 3, GEM Org & Motor Yellow on 1 GEM Red & Motor Red* on 2.

Figure 1B

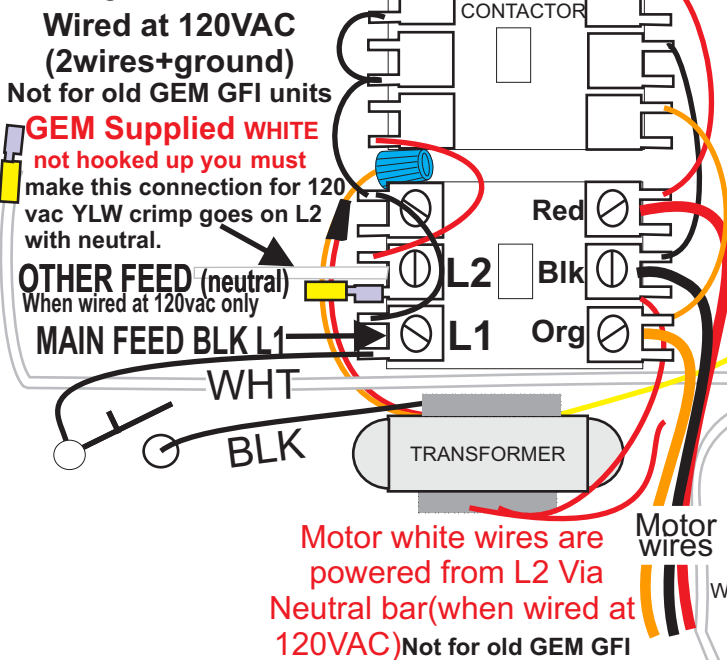

This exploded view is inside the inspection panel of an A.O. SMITH motor wired at 120VAC to a GEM GR2A. **GEM ORANGE WIRE IS ON PIN 2!!!** See previous pages for more motor wire diagrams.

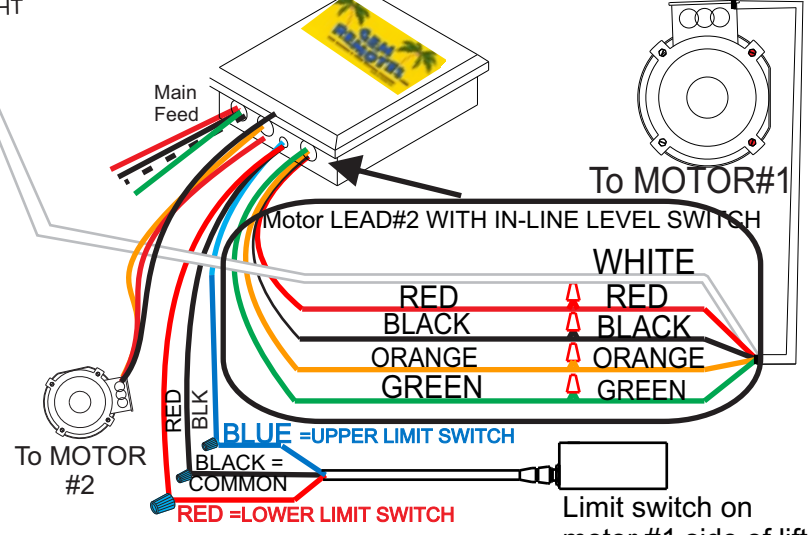
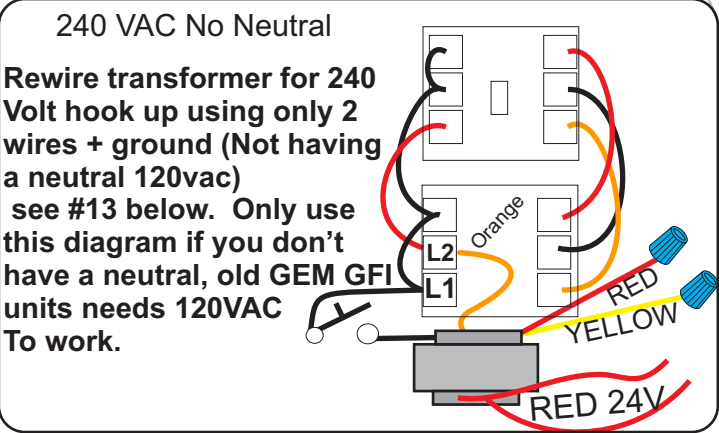
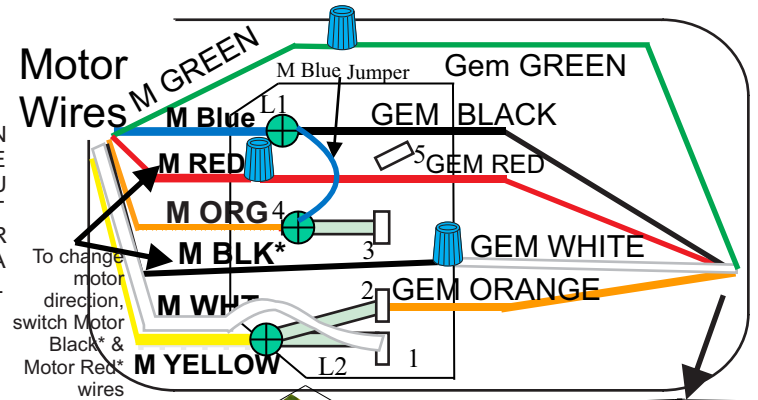

TROUBLESHOOTING:

1. If your remote works but your membrane switch buttons don't work you need to plug in the M/S tail to the receiver board (6 pin connector top left).
 2. You must cut off drum switches: They worked, but the GEM unit only works in one direction. You need to rewire inside motors GEM Orange wire!!
 3. **One or two motors turns in the wrong direction: Switch motor wires**, wires inside the motor, check motor name plate for reversing directions.
 4. **Chatter or grumble in the contactor:** Check for low voltage, when system is running. Check wire size vs run length all the way from the motors to the main breaker at the house. Example 2 3/4hp motors wired at 120vac 180' would need a #3 wire to the GEM unit. The motor wire size would come from the #1 motor chart. Use total distance from the motor to the breaker. 1 3/4hp motor wired at 120vac 200' would be = # 6
 5. **Motor not working:** Color-to-Color wiring inside the motor is incorrect. You must use GEM's motor wire diagrams. **A.O. Smith motors, move GEM Orange wire to pin 2!!** GEM units works with 120/240VAC 1 phase, cap. start, induction run motors. Three phase motors require a special unit please call. 1 1/2 horsepower motors and larger can have a capacitor start and a cap. run. The run cap. might not reverse or the run cap. can explode. It must be removed. This will increase the run amps that the motor will draw by three amps. Eastbay motors, 2 cap systems require no modifications.
 6. Transmitter **does not work** a 3-second delay when switching direction. Check that LED on transmitter lights and check that the learn button LED lights when receiving from the transmitter. Relearn the transmitter, press the learn button 1 time and then push the Stop button the Learn LED should flash.
 7. **Short range or lift hiccups:** If the red LED on the transmitter flickers, **replace the batteries 2: 3Volt CR2032**. Do not change the length of the antenna wire on the receiver board this will not help the range. You should have line of sight for the unit to have up to 300-foot range.
 8. If the GEM unit is dead check that the LED flashes on powered up. If no flash then check your power you can also press in the middle of down contactor if the lift runs, you have main power but your 24 VAC transformer is not working (check neutral). **Auto-Stop units must be hooked up to a limit switch.** A fast flash on the LEDs = the up limit is reached a slow flash = the down limit. If the led are flashing fast then slow then both limits are open check to see if it hooked up or wires damage. **It's against the code & not covered by insurance without a GEM limit switch hooked up.**
 10. **Clearing the memory:** Press and hold the Learn/Clear button for 7 seconds when the LED flashes stop pressing and the memory will be cleared. Test to see if any work. To relearn, press learn button once, then press the Stop button on the transmitter. The Learn LED will flash 2 times.
 11. **TROUBLESHOOTING: Old GEM GFI units needs a neutral. GFI will not reset if it sees a fault or it does not have 120VAC.** Disconnect all motor wires, check to see if the GFI resets, press up and down note contactor pulling in, then hook up 1 motor at a time to find the fault.
 12. **TROUBLESHOOTING: Wiring at 110-120VAC: Motor Hum: 120VAC wiring connect the neutral bar/motor white wire to L2.** See figure 1B. Use Gems supplied white wire and attach to left side of bottom contactor marked L2. Over sizing the circuit breaker can damage your lift, motors and/or the boat. Use the correct size circuit breaker and wire size. Use a wire chart on page 1 and size breakers based on the total horse power of motors.
 13. **TROUBLESHOOTING: Wiring at 220VAC-240VAC 50 to 60hz:** 4 motor or special ordered **240V only units** do not have a Neutral bar. If ordered 240 only, then you only need 2 wires +ground main feed. If you don't have 3+G then you will need to rewire the system for 240VAC only (2+Ground). **Old GEM GFI units needs 120 to work so don't rewire transformer.** Read the label, on top of the transformer BLK-ORG = 240 VAC. Remove yellow wire from neutral bar and cap it off. Find the Orange transformer wire, it should be hiding around the base of the contactor on the left it has a red wire taped to it. Attach the Orange transformer wire to L2. The red wire taped to this wire is used for 208 vac connections don't use.
 14. **TROUBLESHOOTING: Wiring at 208VAC:** Rewire the transformer. Read label on transformer BLK-RED =208 Remove yellow wire from neutral bar and tape it off. Find Red transformer wire, it should be hiding around the base of the contactor on the left it is taped to an Orange wire. Attach Red transformer wire to L2. The Orange wire that it was taped to is for 240 connections. GFI units need a 120vac to work.
- Need more help?** Call 239-642-0873 M-F 9:00-5:00 EST. The web page also has more information for after hours help.